

Hardware #900937

- (A)**  8pc - Bolts & Nuts
- (B)**  8pc - 1 3/8" screws
- (C)**  4pc - 1" screws
- (D)**  3pc - Stars

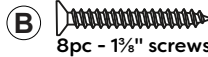

Step 1 Connect the Front Panel and the Back Panel to the Left Side Panel and Right Side Panel using 8 - Bolts & Nuts (A).

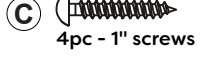
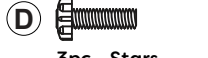
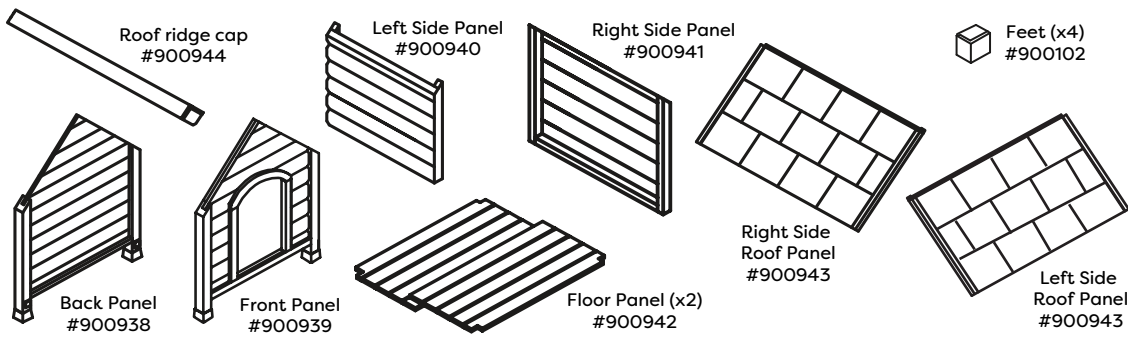
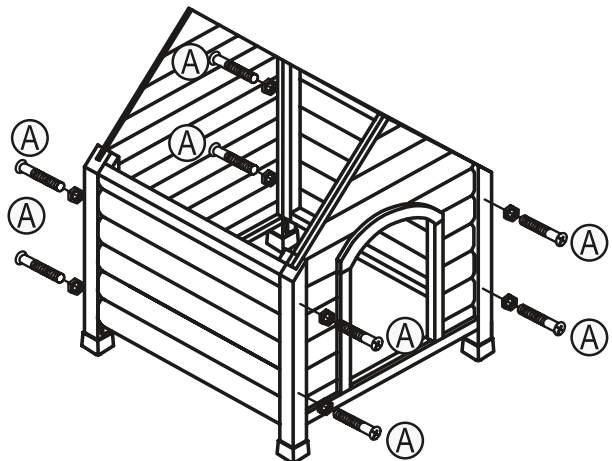

Step 2 Insert the two piece Floor Panel into the assembled doghouse. The corners of the Floor Panels are notched to fit the outside corners.

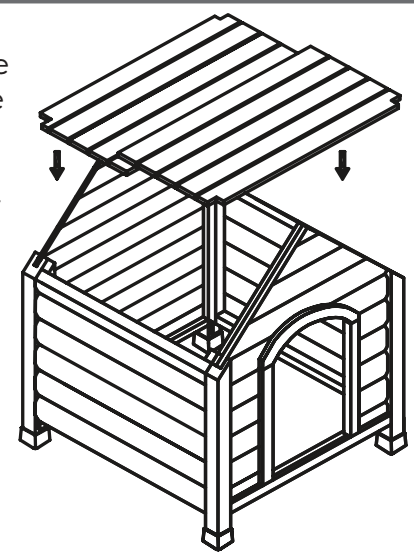

Step 3 Attach the Right Side Roof Panel and the Left Side Roof Panel to the assembled doghouse using 8 - 1 3/8" screws (B).

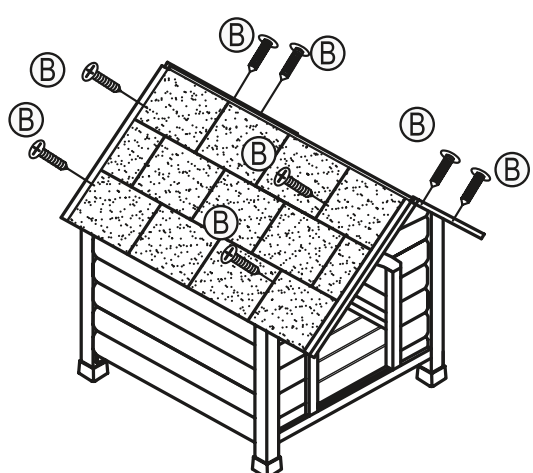

Step 4 Place the Roof Ridge Cap onto the Shingle Roof Panels and secure using 4 - 1" screws (C). Attach 3 - Star shaped bolts (D) onto the dog door frame in the threaded holes.

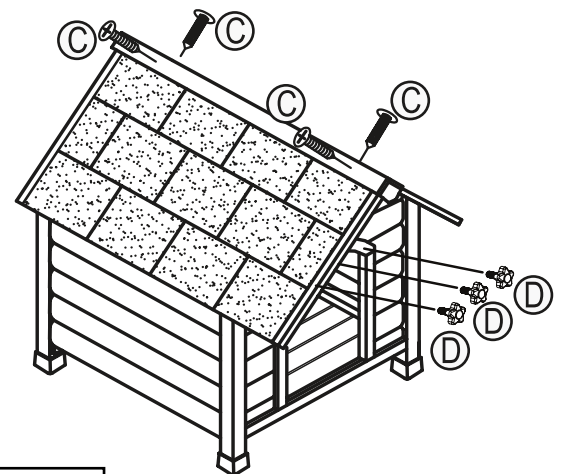

ware cares[™]
We care about the carbon pawprint we leave as a company and are committed to using recycled and recyclable material in the manufacturing of our packaging and pet products.

Care Tip

To protect the wood on your premium+ doghouse you need to re-apply the protective stain finish at least 1x each year. Use a safe and non-toxic water based stain (available at your local paint or hardware center). Keep doghouse in a safe area away from high winds and extreme temperatures.