

ready to assemble -- tools required:  
electric drill with phillips bit and/or a phillips screwdriver, small pair of pliers

item #15056  
overall dimensions  
59" L X 76" W X 47" H  
149.8 cm x 193 cm x 119.4 cm

**carriage house  
assembly instructions**

[warepet.com](http://warepet.com)

Thank you for your purchase. Follow these detailed instructions to properly assemble your new **carriage house coop**. To ensure assembly success, please read all care guides carefully prior to assembly and installation.

### **warnings & cautions**



- Coop should be placed on a flat level surface for stability.
- Keep small parts away from pets/children to avoid choking hazard.
- Follow instructions in this manual to avoid personal injury to pet or property damage.
- This coop is for chicken use only, it is not suitable for children or other animals.
- Keep all tools and instructions in a safe place for future reference.
- Always supervise your flock when using this item. Inspect product regularly and re-tighten screws as needed.
- For additional stability, coop can be anchored to the ground.





[warepet.com](http://warepet.com)

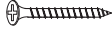
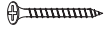

If you have any questions or concerns about this product contact our customer service department at 1-800-295-2243 Mon-Fri 8:00 - 4:00 MST or email us at [hello@warepet.com](mailto:hello@warepet.com)

Due to ongoing product improvements, product photo on packaging may not match finished product.

# HARDWARE & PARTS

- A**  2" (3.5 x 50mm) 12pcs #902737
- B**  1-1/2" (3.5 x 40mm) 50pcs #902738
- C**  1-3/16" (3.5 x 35mm) 22pcs #902739

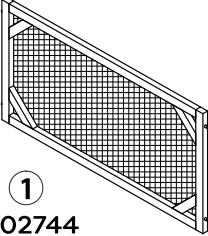
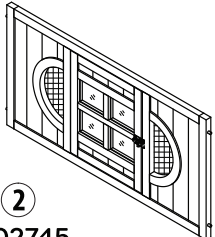
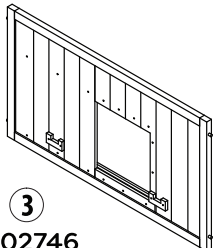
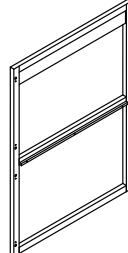
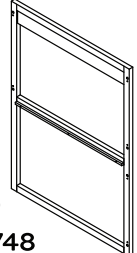
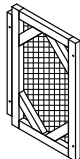
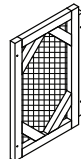
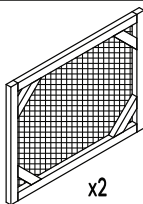
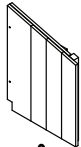
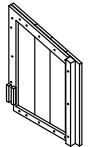
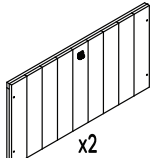
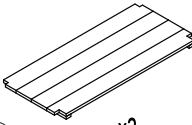
- D**  1" (3.5 x 25mm) 12 pcs #902740
- E**  7/8" (3.0 x 23mm) 24 pcs #902741
- F**  1/2" (3.0 x 14mm) 8 pcs #902742
- G**  1 pc #902743

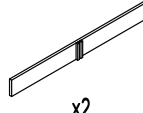
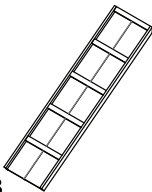
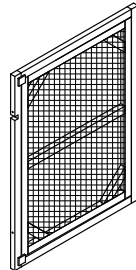
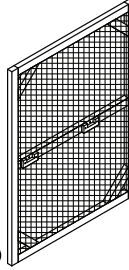
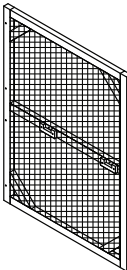
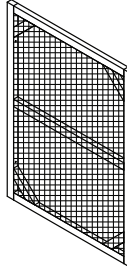
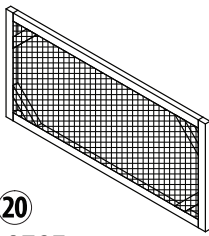
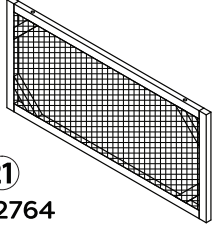
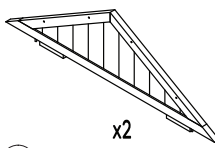
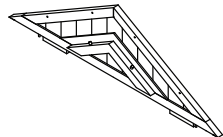
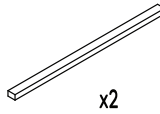
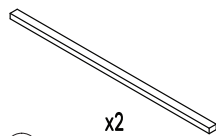
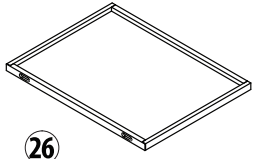
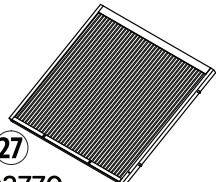
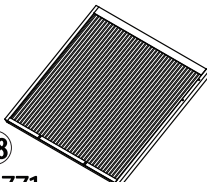
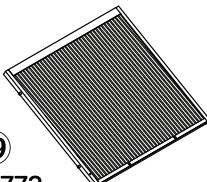
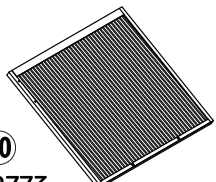
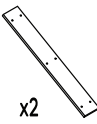
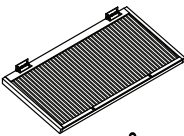
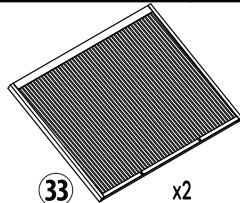
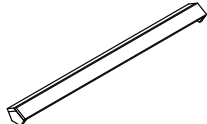
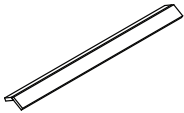
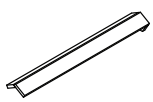
 <b>1</b> #902744	 <b>2</b> #902745	 <b>3</b> #902746	 <b>4</b> #902747	 <b>5</b> #902748
 <b>6</b> #902749 x2	 <b>7</b> #902750 x2	 <b>8</b> #902751 x2	 <b>9</b> #902752 x2	 <b>10</b> #902753 x2
 <b>11</b> #902754 x2	 <b>12</b> #902755 x2	 <b>13</b> #902756 x2	 <b>14</b> #902757 x2	 <b>15</b> #902758
 <b>16</b> #902759	 <b>17</b> #902760	 <b>18</b> #902761	 <b>19</b> #902762	 <b>20</b> #902763
 <b>21</b> #902764	 <b>22</b> #902765 x2	 <b>23</b> #902766	 <b>24</b> #902767 x2	 <b>25</b> #902768 x2
 <b>26</b> #902769	 <b>27</b> #902770	 <b>28</b> #902771	 <b>29</b> #902772	 <b>30</b> #902773
 <b>31</b> #902774 x2	 <b>32</b> #902775 x2	 <b>33</b> #902776 x2	 <b>34</b> #902777	 <b>35</b> #902778
				 <b>36</b> #902779

warepet.com

If you have any questions or concerns about this product contact our customer service department at 1-800-295-2243 Mon-Fri 8:00 - 4:00 MST or email us at hello@warepet.com

Due to ongoing product improvements, product photo on packaging may not match finished product.

### STEP 1

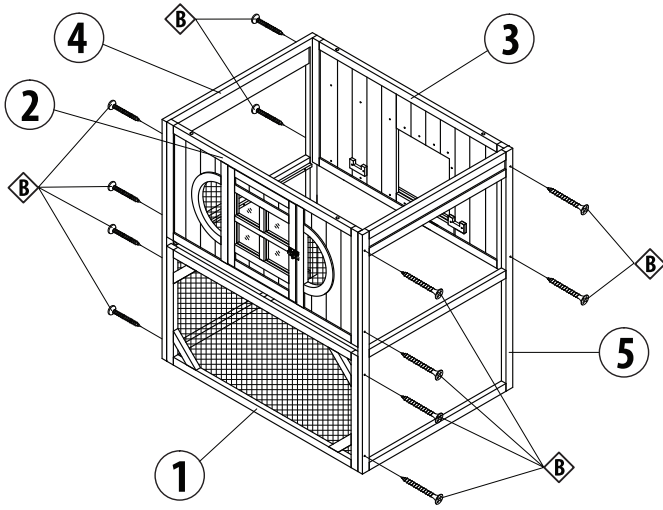

**B**  1-1/2" (3.5 x 40mm) 12pcs

### STEP 2

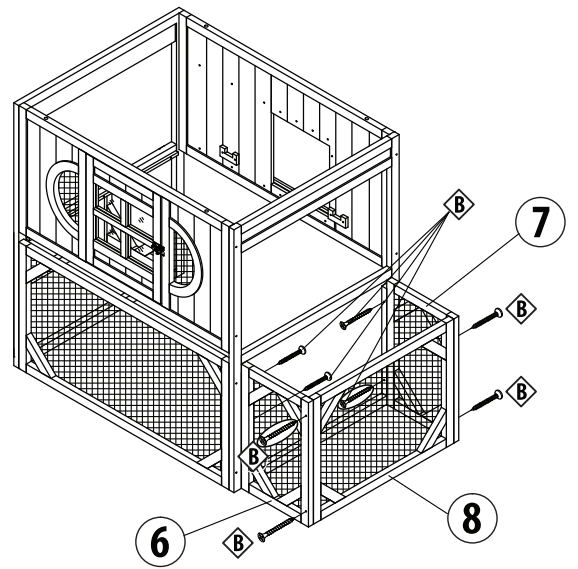

**B**  1-1/2" (3.5 x 40mm) 8pcs

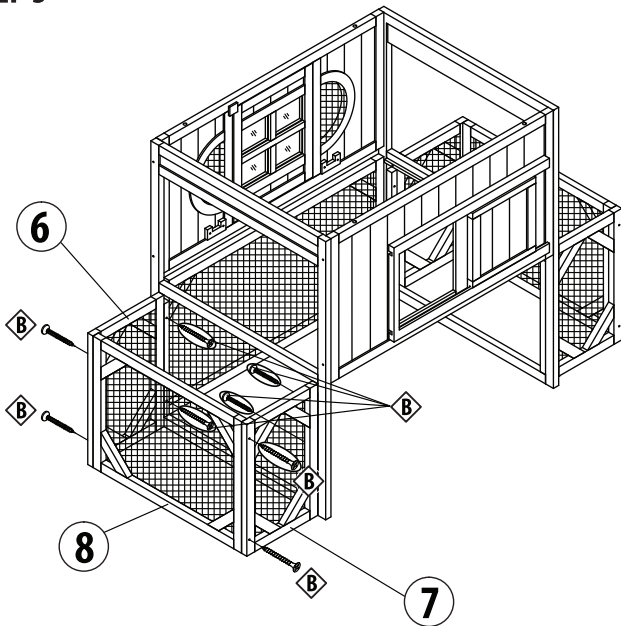

### STEP 3



**B**  1-1/2" (3.5 x 40mm) 8pcs

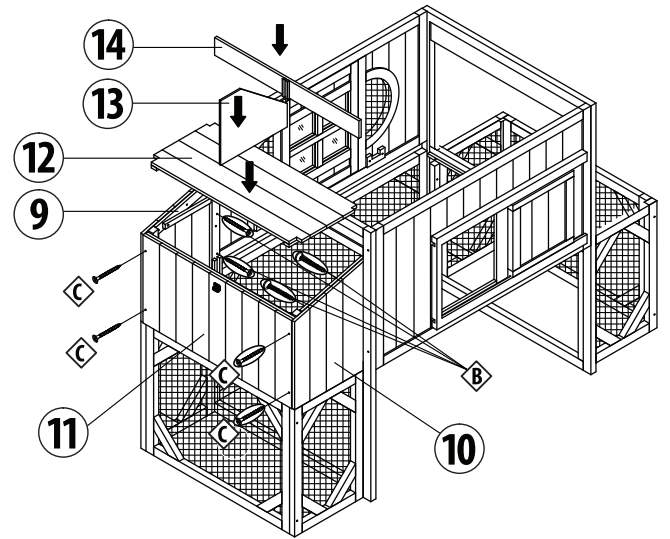

### STEP 4



**B**  1-1/2" (3.5 x 40mm) 4pcs  
**C**  1-3/16" (3.5 x 35mm) 4pcs

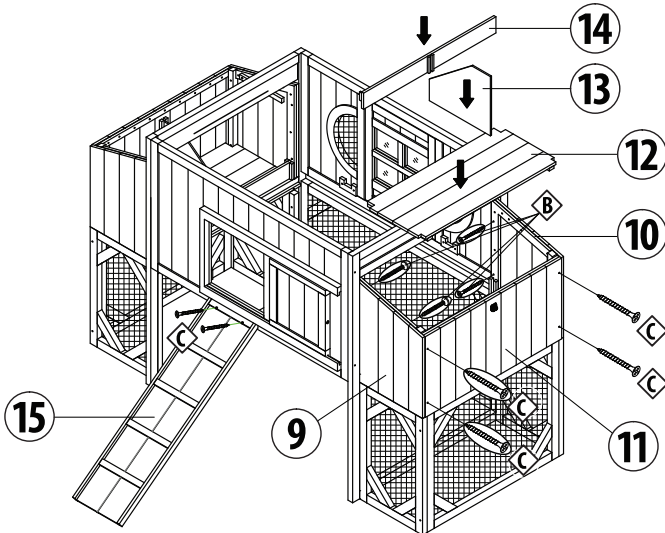

### STEP 5

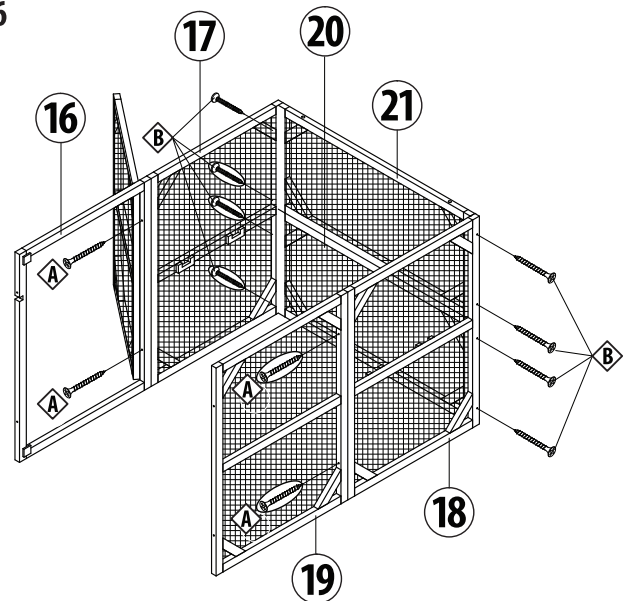

**B**  1-1/2" (3.5 x 40mm) 4pcs  
**C**  1-3/16" (3.5 x 35mm) 6pcs

### STEP 6



**A**  2" (3.5 x 50mm) 4pcs  
**B**  1-1/2" (3.5 x 40mm) 8pcs

## STEP 7

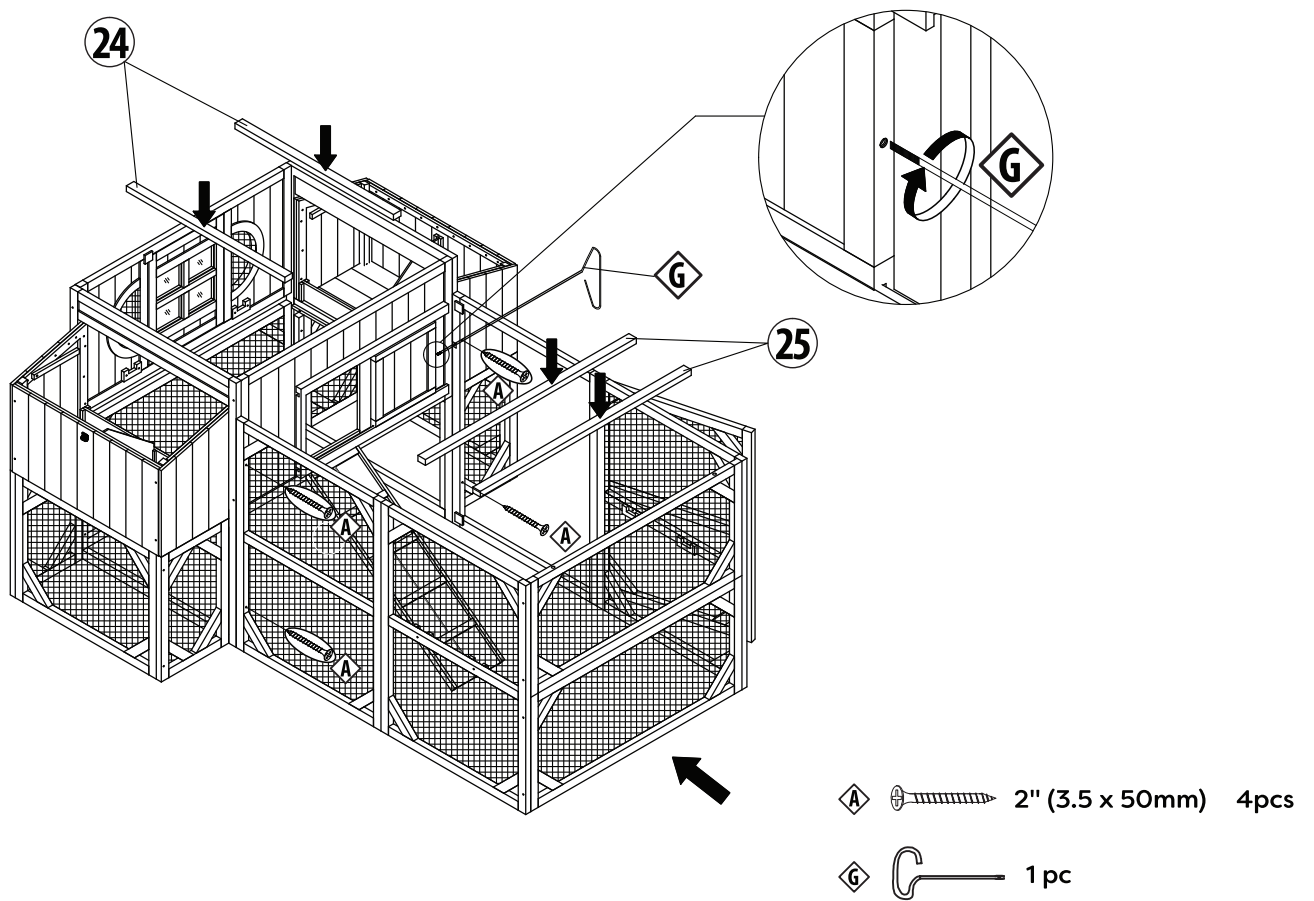

## STEP 8

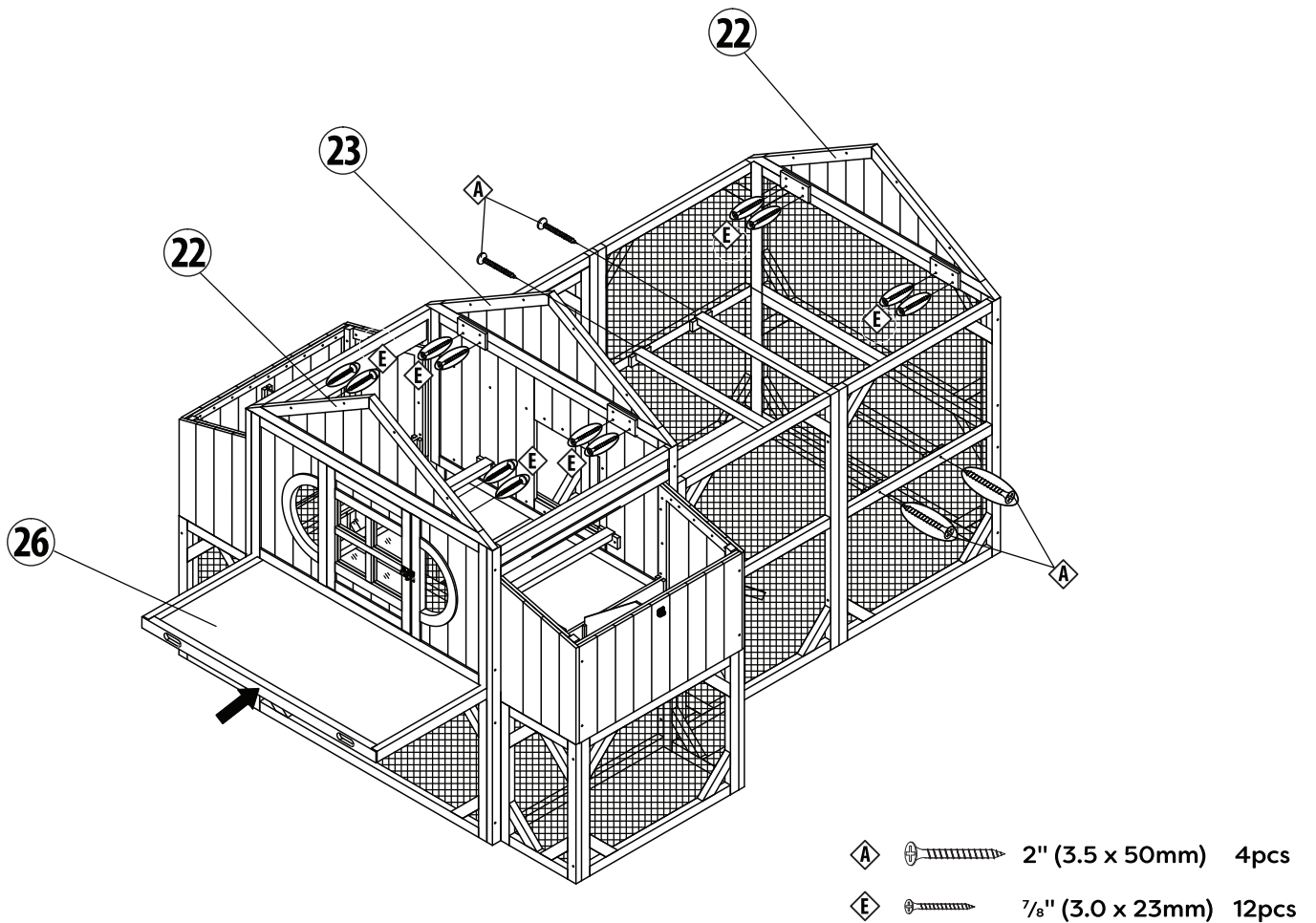

## STEP 9

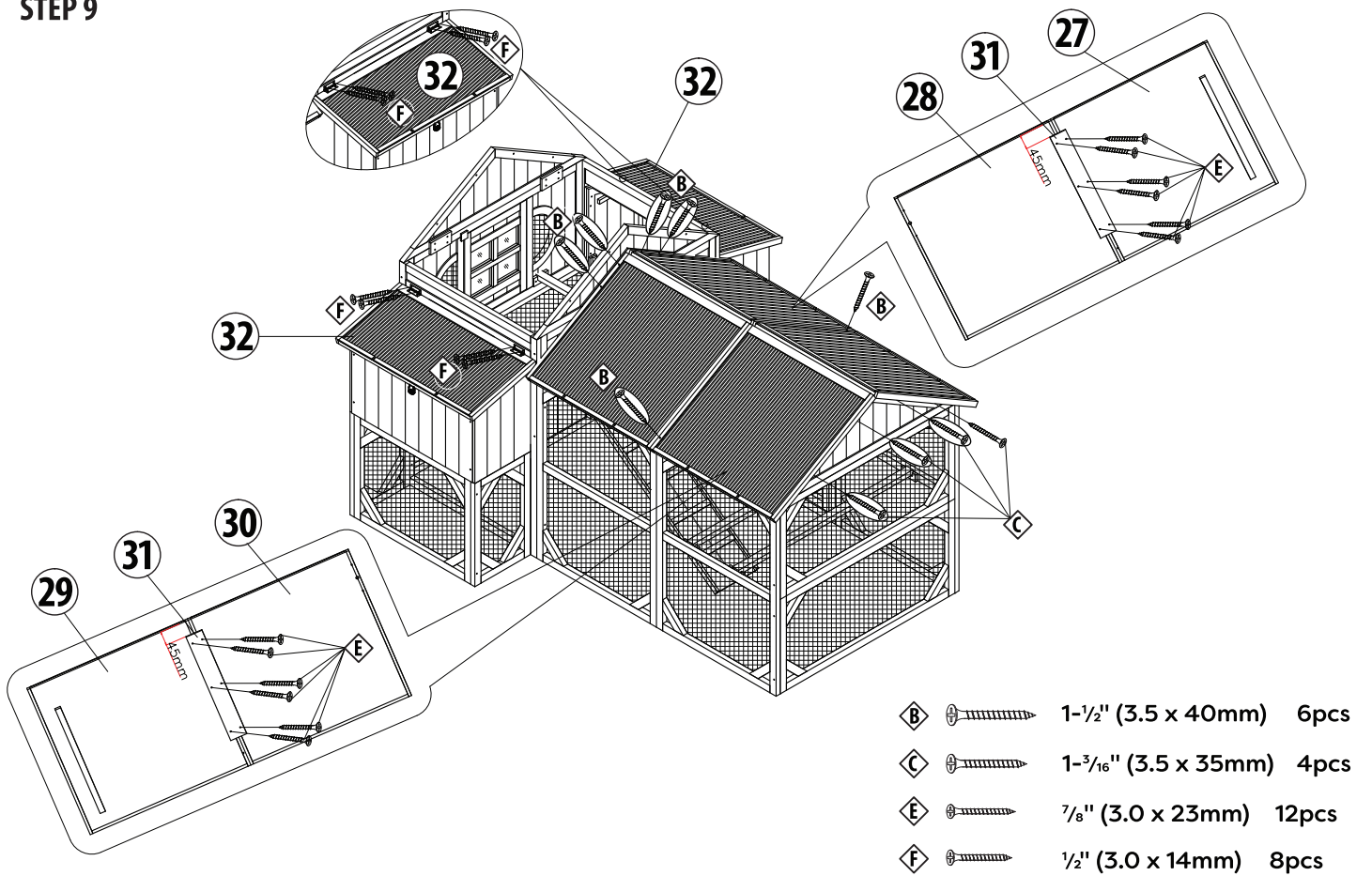

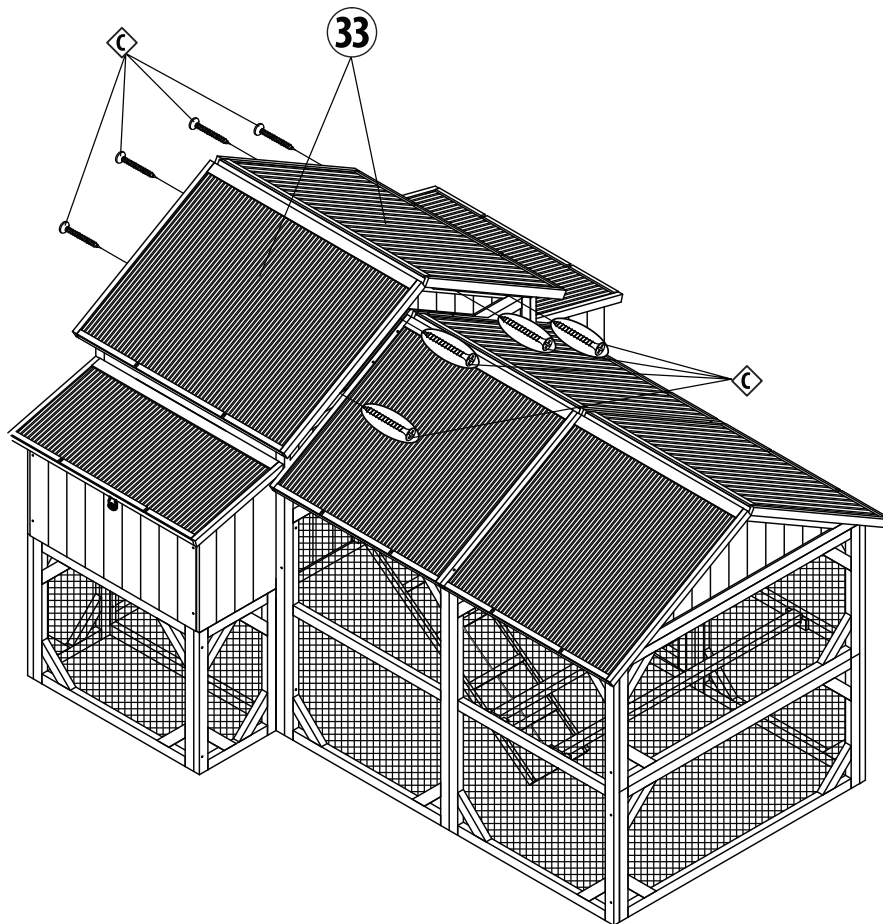

## STEP 10

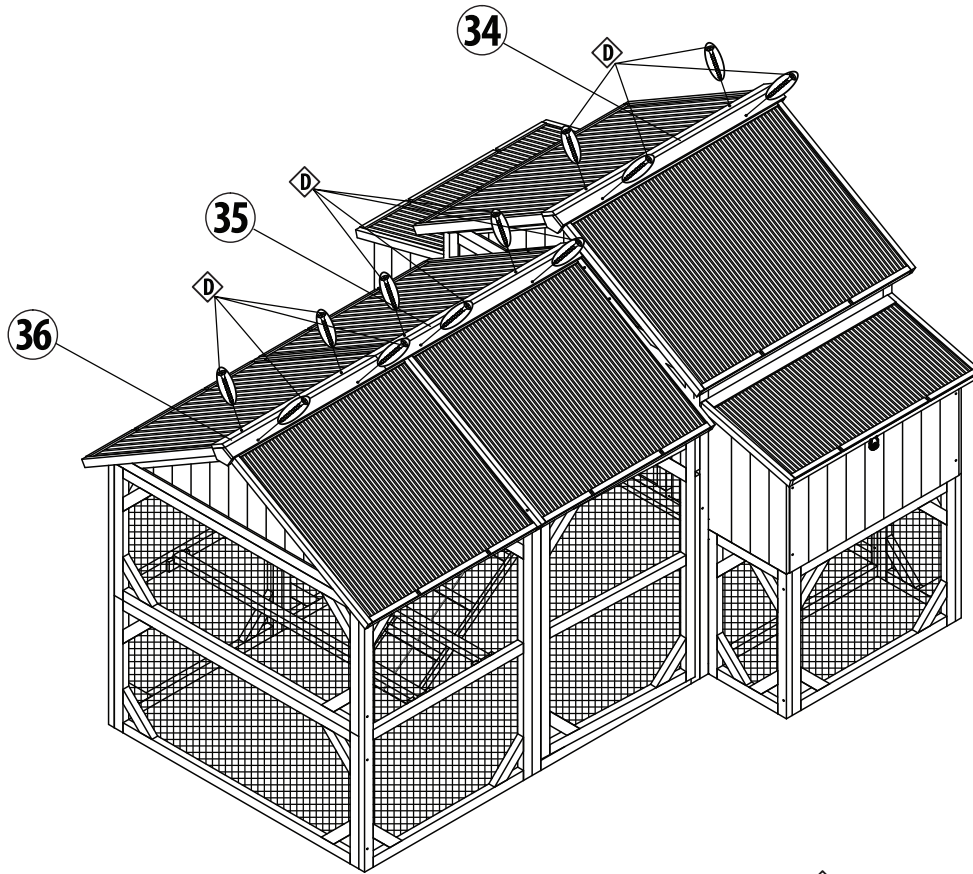

**C**  1-3/16" (3.5 x 35mm) 8pcs

## STEP 11



 1" (3.5 x 25mm) 12pcs

**Assembly is now complete**

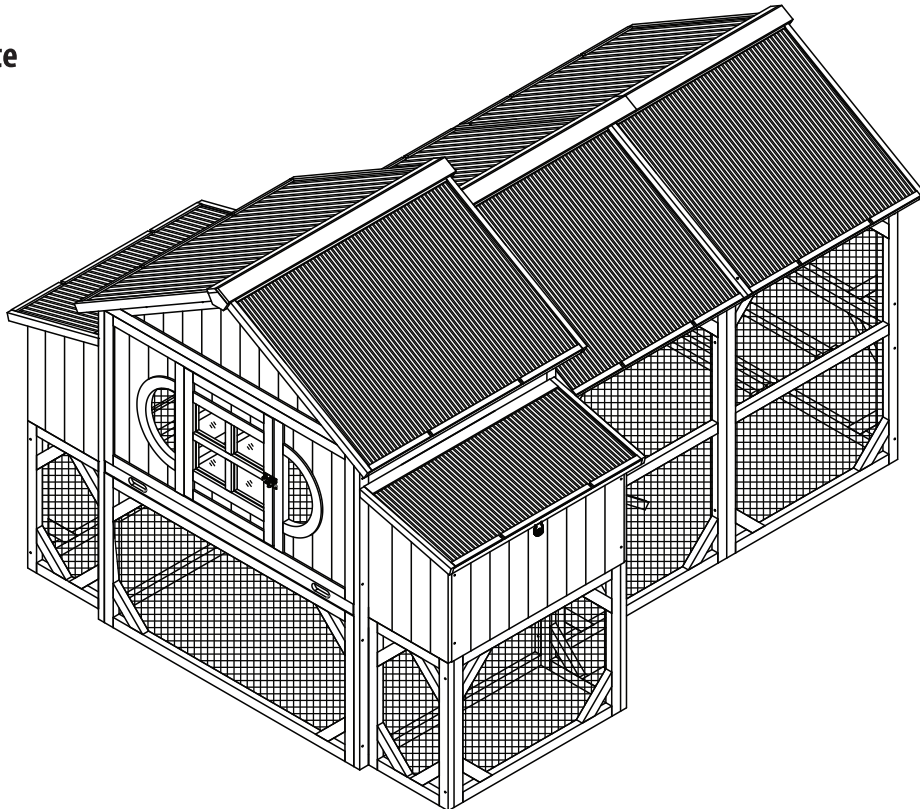

### **care tip**

To protect the wood on your pen you need to re-apply the protective stain finish at least 1x each year. Use a safe and non-toxic water based stain (available at your local paint or hardware center). Keep pen in a safe area away from high winds and extreme temperatures.