

ready to assemble -- tools required:
electric drill with phillips bit and/or a phillips screwdriver, small pair of pliers

item #15061
overall dimensions
62.2" L X 22.4" W X 32" H
158 cm x 57 cm x 81.7 cm

**pioneer coop
assembly instructions**
warepet.com

Thank you for your purchase. Follow these detailed instructions to properly assemble your new **pioneer coop**. To ensure assembly success, please read all care guides carefully prior to assembly and installation.

warnings & cautions

- Coop should be placed on a flat level surface for stability.
- Keep small parts away from pets/children to avoid choking hazard.
- Follow instructions in this manual to avoid personal injury to pet or property damage.
- This coop is for chicken use only, it is not suitable for children or other animals.
- Keep all tools and instructions in a safe place for future reference.
- Always supervise your flock when using this item. Inspect product regularly and re-tighten screws as needed.
- For additional stability, coop can be anchored to the ground.



warepet.com

If you have any questions or concerns about this product contact our customer service department at 1-800-295-2243 Mon-Fri 8:00 - 4:00 MST or email us at hello@warepet.com

Due to ongoing product improvements, product photo on packaging may not match finished product.

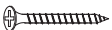
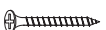
HARDWARE & PARTS

- A**  (M6 x 50mm) 4pcs #902842
- B**  2" (3.5 x 50mm) 6pcs #902843
- C**  1-1/2" (3.5 x 40mm) 16pcs #902844

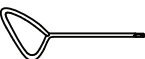
- D**  1-3/8" (3.5 x 35mm) 14pcs #902845
- E**  1" (3.5 x 25mm) 6pcs #902846
- F**  1/2" (3.0 x 16mm) 4pcs #902847
- G**  1 pc #902900

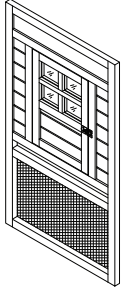
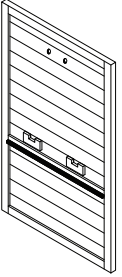
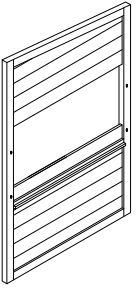
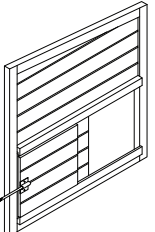
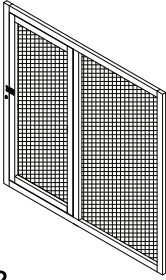
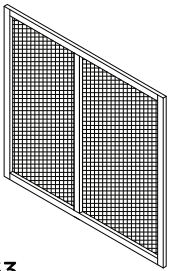
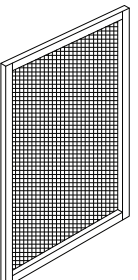
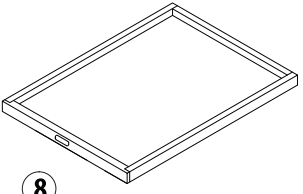
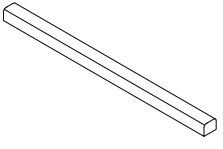
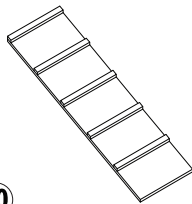
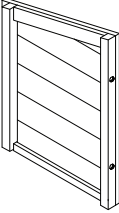
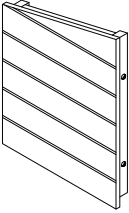
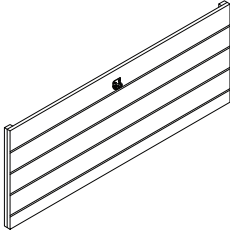
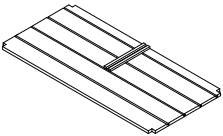
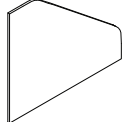
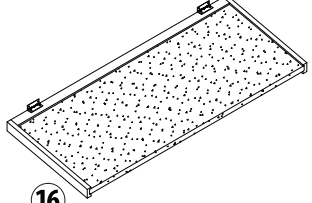
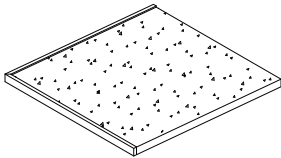
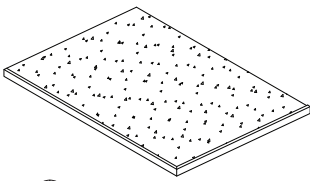
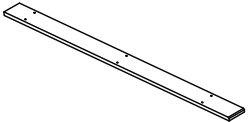
 1 #902848	 2 #902849	 3 #902850	 4 #902851
 5 #902852	 6 #902853	 7 #902854	 8 #902855
 9 #902856	 10 #902857	 11 #902858	 12 #902859
 13 #902860	 14 #902861	 15 #902862	 16 #902863
 17 #902864	 18 #902865	 19 #902866	

warepet.com

If you have any questions or concerns about this product contact our customer service department at 1-800-295-2243 Mon-Fri 8:00 - 4:00 MST or email us at hello@warepet.com

Due to ongoing product improvements, product photo on packaging may not match finished product.

STEP 1

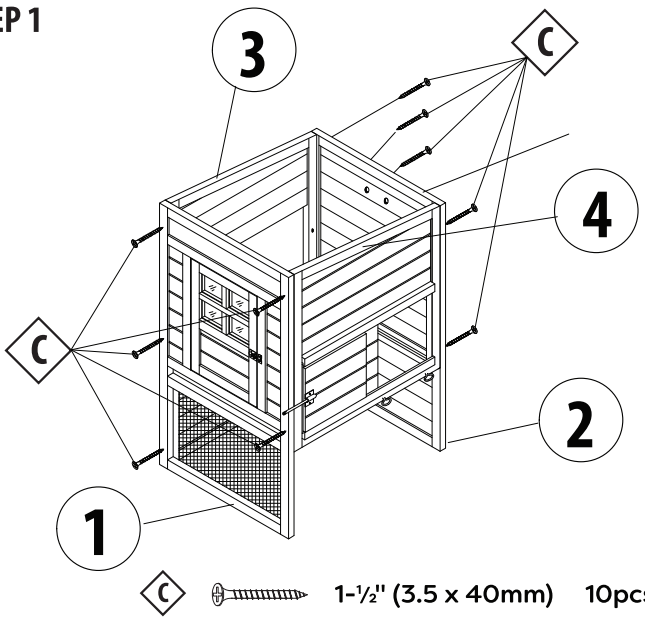

C  1-1/2" (3.5 x 40mm) 10pcs

STEP 2

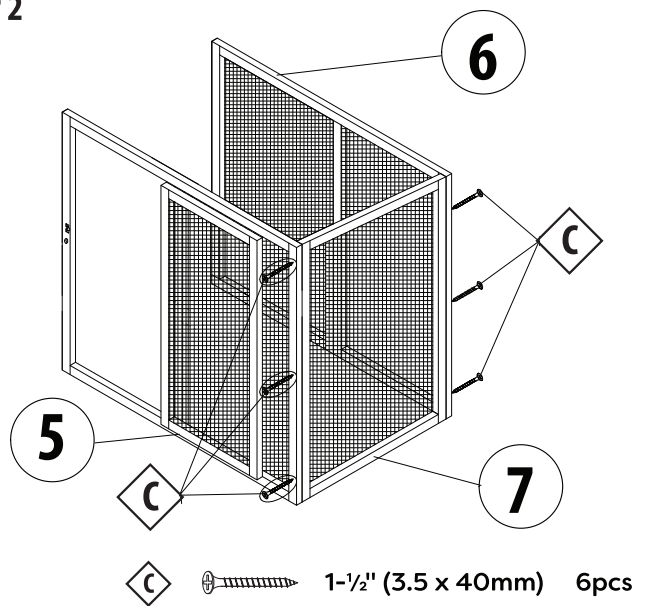

C  1-1/2" (3.5 x 40mm) 6pcs

STEP 3

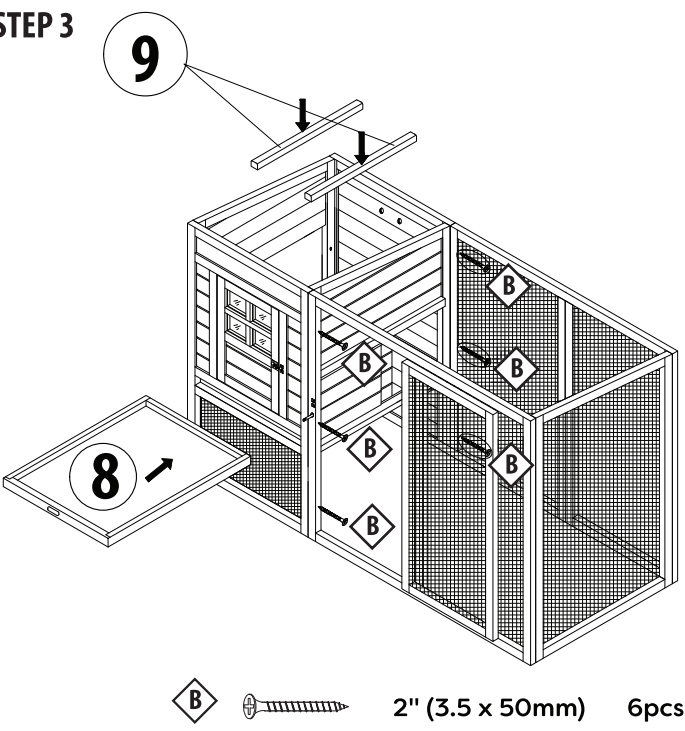

B  2" (3.5 x 50mm) 6pcs

STEP 4

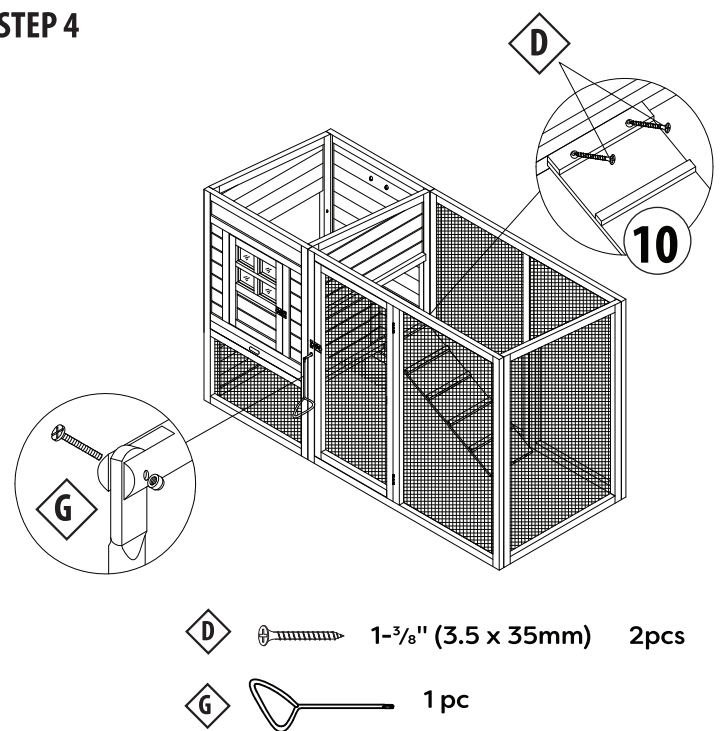

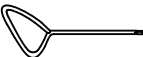

D  1-3/8" (3.5 x 35mm) 2pcs

G  1 pc

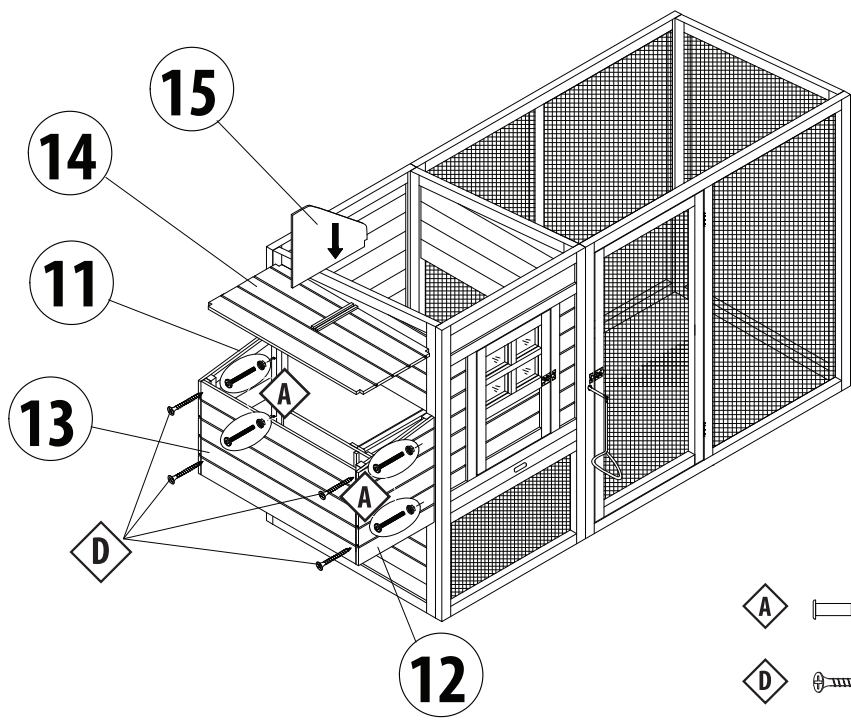
STEP 5





A  (M6 x 50mm) 4pcs

D  1-3/8" (3.5 x 35mm) 4pcs

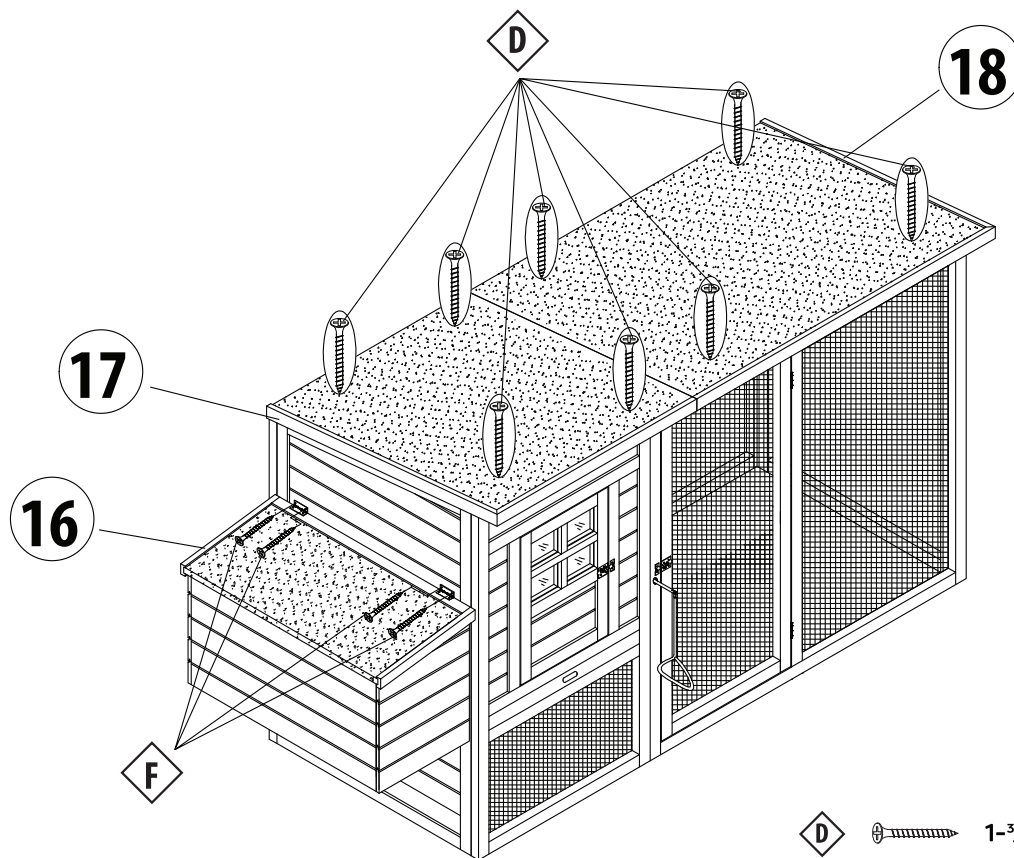
STEP 7



D  1-³/₈" (3.5 x 35mm) 8pcs

F  1/2" (3.0 x 16mm) 4pcs

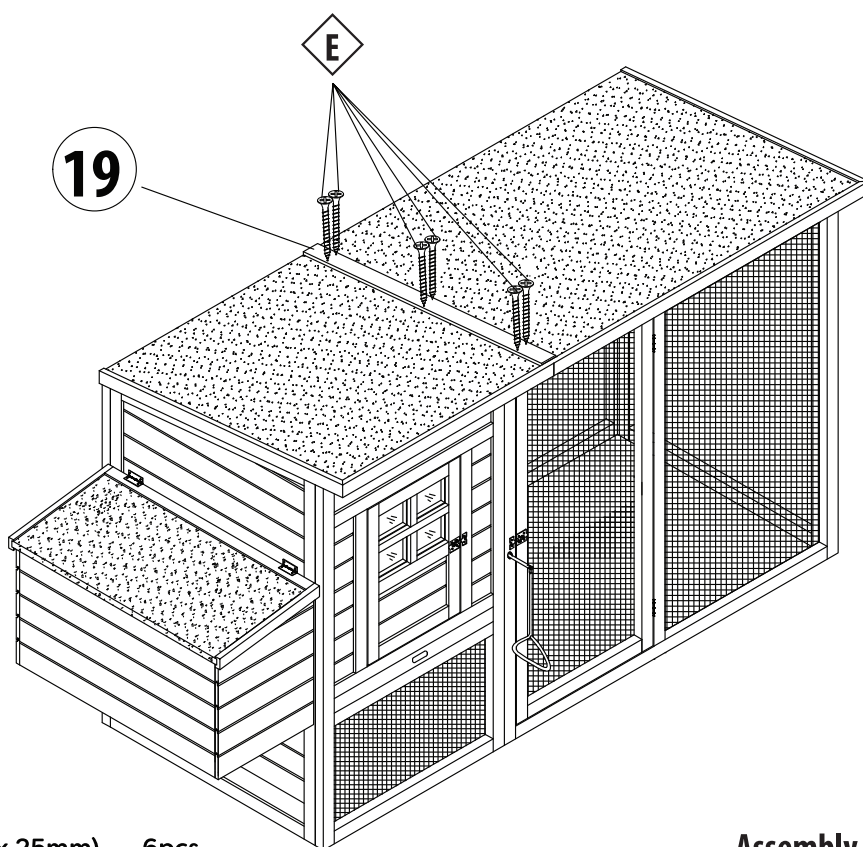

E  1" (3.5 x 25mm) 6pcs

Assembly is now complete

care tip

To protect the wood on your pen you need to re-apply the protective stain finish at least 1x each year. Use a safe and non-toxic water based stain (available at your local paint or hardware center). Keep pen in a safe area away from high winds and extreme temperatures.